

Bottle Traps









SPECIFICATION

PRODUCT CODE

A186-E



FINISH

	CHROME NRA186eCH		MATTE BLACK NRA186eMB
	GUN METAL NRA186eGM		BRUSHED NICKEL NRA186eBN
	BRUSHED GOLD NRA186eBG		BRUSHED BRONZE NRA186eBZ
	GRAPHITE NRA186eGR		MATTE WHITE NRA186eMW
	AGED BRASS NRA186eAB		

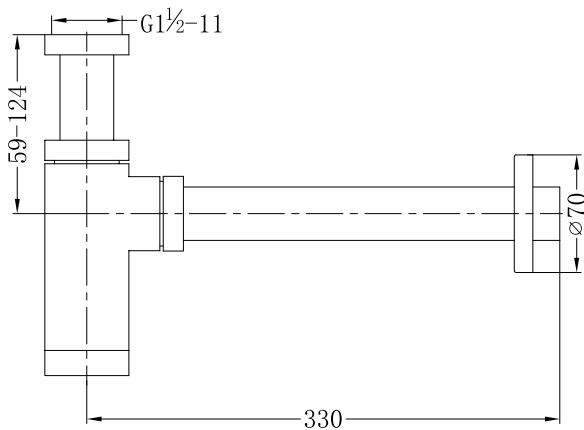

Dimensions are nominal measurements only.

MAINTENANCE AND CARE

All surfaces should be cleaned with mild liquid detergent or soap and water.

Do not use cream cleaners or citrus based cleaning products, as they are abrasive.

Use of unsuitable cleaning agents may damage the surface. Any damage caused in this way will not be covered by warranty.

PACKING INCLUDES

- 1x bottle trap
- 1x installation kit



Install Instruction

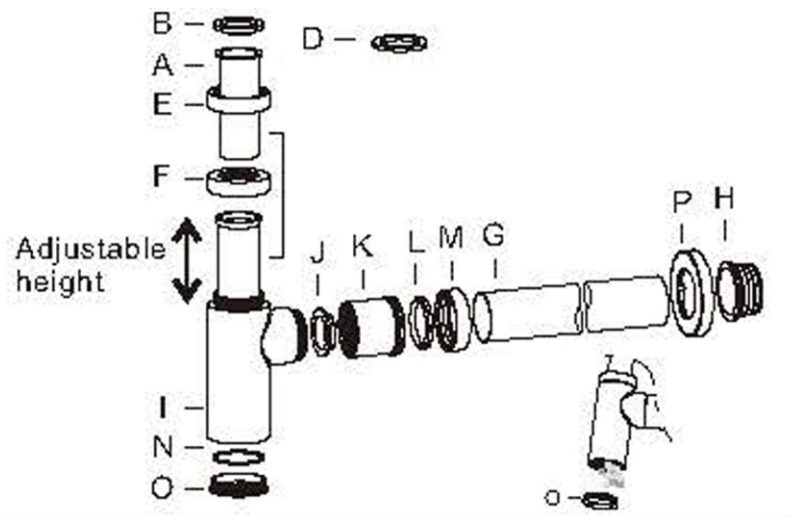

1. Install the Basin waste as per Basin waste installation instructions.
2. Cut the protruding part of wall drain pipe from the wall or the back of the vanity cabinet leaving 1mm to 5mm protruding. The pipe should be cut square to the wall/vanity cabinet and deburred.
3. Fit Union (J,K,L,M) to Out let side of Bottle trap (I). Do not completely tighten as removal and adjustment will be required during installation.
4. Fit the Bottle trap to the Plug and Waste using sealing washer (D) do not completely tighten as removal and adjustment of the bottle trap will be required during installation.
5. Lubricate end of Bottle trap outlet pipe (G) with plumbers grade grease or soapy water, fit Key seal (H) supplied to end of Outlet pipe (G).
6. Slide outlet pipe (G) with rubber Key seal (H) into wall drain pipe until raised edge of Key seal (H) is against wall drain pipe.
7. Loosen compression nut (F) and adjust height of bottle trap inlet pipe (A) and align outlet pipe (G) to the side of the bottle trap outlet assembly (J,K,L,M). Mark outlet pipe 30mm longer than compression nut (M) edge when Outlet assembly (J,K,L,M) is fully assembled. Cut the outlet pipe (G) using pipe cutter and deburr pipe edges. Slide wall flange (P) onto outlet pipe.
8. Remove Bottle trap from waste. Assemble outlet pipe (G) to Bottle trap, do not tighten completely as adjustment will be required during installation.
9. Lubricate Key seal (H) on end of Outlet pipe, Push Key seal and pipe into wall drain pipe.
10. Reconnect Bottle trap to Plug and Waste.
11. Adjust Bottle trap to required position and tighten all connections.
12. Fill Basin with water and drain. Check Bottle trap for any leaks.

